

# BODY COMPOSITION ANALYZER

## MC-780MA-N

### Instruction Manual

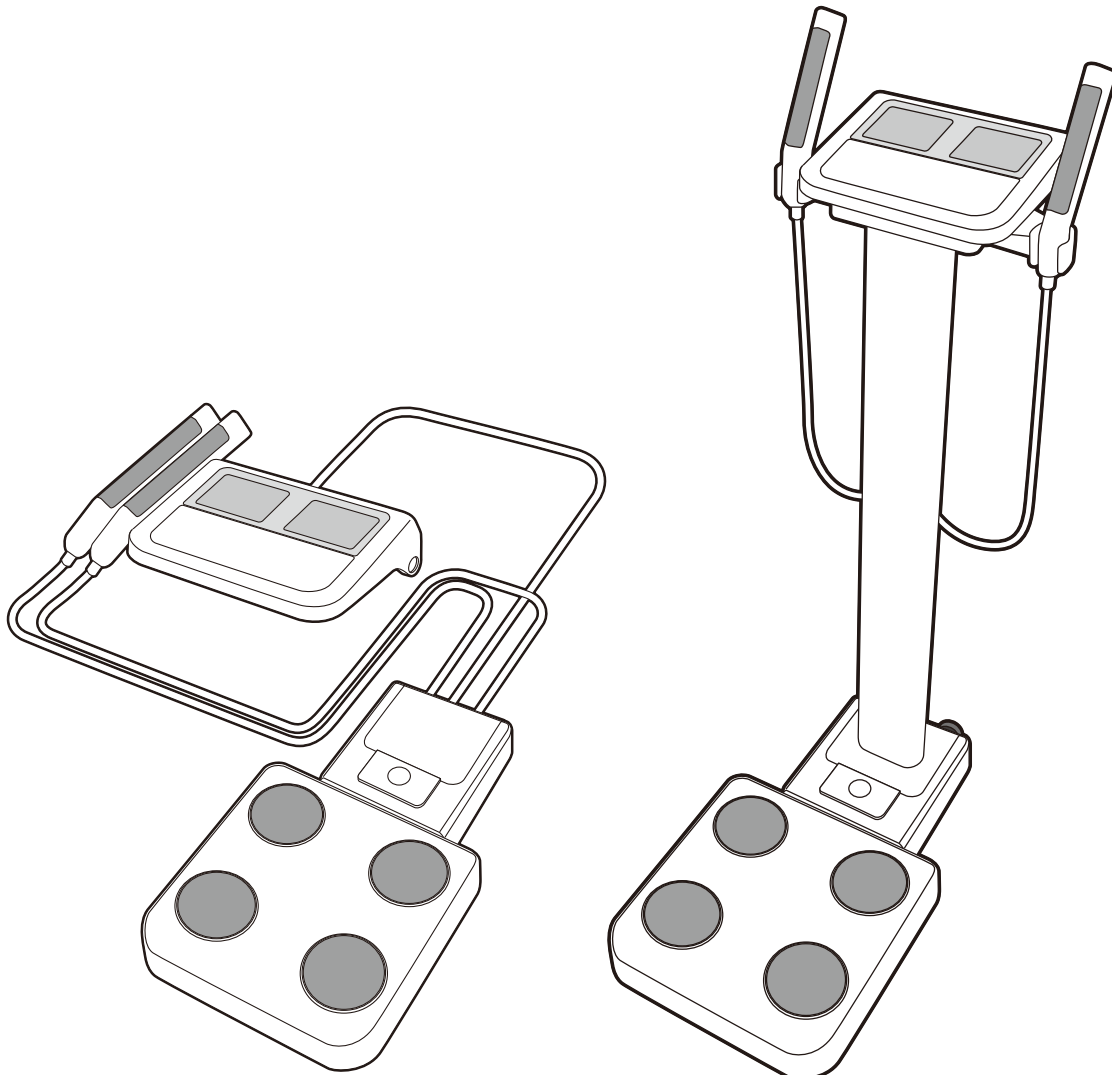

Separate Version

Column Mounted Version

#### <Usage Conditions>

Temperature	: 5 to 35°C
Relative Humidity	: 30 to 80% (without condensation)
Maximum Altitude	: 2,000m ASL
Atmospheric Pressure Range	: 86 to 106kPa

#### <Storage Conditions>

Temperature	: -10 to 50°C
Relative Humidity	: 10 to 90% (without condensation)
Atmospheric Pressure Range	: 70 to 106kPa

To avoid malfunctions, avoid storing the equipment in a place with direct sunlight, significant temperature changes, a risk of dampness, a large amount of dust or a risk of vibration or impact, or in the vicinity of flames.



Please read this Instruction Manual carefully and keep it for future reference.

## Intended Use

TANITA Body Composition Analyzers have been clinically proven to be accurate, reliable and provide highly repeatable results. Our Analyzers are used worldwide by health, research and medical professionals primarily in the following fields:

- medical screening and health assessments of adults and children
- monitoring the progress of weight loss during medical treatment relating to lifestyle diseases such as diabetes, hyperlipidemia, bariatric surgery, hypertension and fatty liver disease.
- monitoring increases of muscle mass, reduction of body fat and hydration levels as part of a fitness or training program
- assessing the true effectiveness of nutrition and physical activity programs where body mass index cannot identify key changes in body composition
- collating subject data for large cohort research studies

## Efficacy

This product has been specifically designed to be simple to use and required no additional user assistance to take a measurement.

Measurements can be taken in under 30 seconds for maximum convenience.

# Contents

## Before Use

<b>For Your Safety</b> .....	<b>4</b>
<b>Part Names &amp; Connection Procedure</b> .....	<b>8</b>
<b>Power Supply</b> .....	<b>10</b>
<b>Settings</b> .....	<b>11</b>

## How to Use

<b>Taking a Measurement</b> .....	<b>13</b>
Body Composition Mode .....	13
Measurement Results .....	15
Scale Mode .....	17
Weight Lock Mode .....	18
General Instructions for Body Composition Measurement .....	19
Judgment Results .....	19
Body Water and Extracellular Water .....	20
<b>Output and Storage of Measurement Results</b> ....	<b>21</b>

## If Necessary

<b>Troubleshooting</b> .....	<b>23</b>
<b>Specifications</b> .....	<b>24</b>

# For Your Safety

en

Before Use

This section explains precautionary measures to be taken to avoid injury to the users of this device and others, and to prevent damage to property. Please familiarise yourself with this information to ensure safe operation of this equipment.

 **Warning** Failure to follow instructions highlighted with this mark could result in death or severe injury.

 **Caution** Failure to follow instructions highlighted with this mark could result in injury or damage to property.



Prohibited

This mark indicates actions that are prohibited.



Required

This mark indicates instructions that must always be followed.

## Warning

**This equipment must not be used on subjects with pacemakers or other mechanical implants.**

This equipment passes a weak electrical current through the body which could interfere with and cause the malfunction of electrical medical implants, resulting in serious harm.



**Do not handle the plug with wet hands.**

This may result in electric shock, fire, or leakage.



Prohibited

**Keep this equipment away from flammable gas and oxygen-rich environments.**



**Do not modify this equipment in any way.**

This can cause electric shock or injury, or affect the accuracy of analysis.

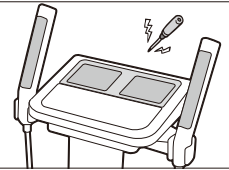

**Do not use a multi-plug adapter.**

This may cause fire.

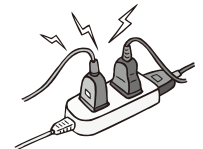

## Caution



Prohibited

**Keep away from water.**

**Avoid using on subjects with metal allergies.**

Allergic reactions may be caused by the stainless steel used in the electrodes of this device.

**Do not jump on the equipment.**

**Do not lean on the equipment.**

**Do not use this equipment near other products that emit electromagnetic waves.**

**Do not insert fingers into gaps or holes.**

**Do not apply force to the display.**

The screen panel may break and cause injury.

**Do not place items sensitive to magnetic forces near the equipment.**

The magnet of the impedance meter may cause corruption of data on devices such as USB memory sticks if these are placed near the equipment.

**Assist persons with disabilities.**

Another person should assist persons with disabilities who may not be able to take a measurement alone.



Required

**Clean the scale platform with appropriate disinfectant after each use.**

**Stand clear of the subject during measurement to ensure accuracy.**

**Continually monitor both the subject and the equipment for anomalies.**

If an anomaly in the subject or equipment is discovered, take appropriate action, such as stopping the equipment, while ensuring the safety of the subject.

**Use the included AC adapter. (TR30M120)**

**Do not lean against the equipment.**

**Unplug the AC cable from the equipment when moving it.**

**Tighten the adjustable feet when moving the equipment.**

**Interpretation of analysis results (e.g. evaluation of measurements and formulation of exercise programmes based on results) must be performed by a professional.**

Weight loss measures and exercise based on self-analysis could be harmful to you health. Always follow the advice of a qualified professional.

**This equipment is designated a Class B IT device (mainly for systems intended to be used in internal environments) and is CE (EMC) certified, but it may affect devices that are sensitive to electromagnetic waves.**

If connecting a computer or peripheral devices to this equipment, please use devices complying with IEC60601-1 (EN60601-1). Power must be supplied from a medical isolation transformer for IEC60950(EN60950) devices. Keep a distance of 1.5m between units during operation. Failure to do so may cause electric shock to subjects or malfunction.

# For Accurate Measurements



Prohibited

**Avoid measuring after strenuous exercise.**

This may cause inaccurate measurements. Please take measurements after sufficient rest.



**Avoid measuring after excessive food or fluid intake or when dehydrated.**

This may cause inaccurate measurements. For greater accuracy, avoid using directly after waking up. Use at the same time on each occasion, at least three hours after a meal.

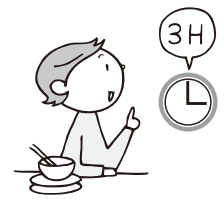

**Ensure arms are not touching sides and inner thighs are not touching each other during measurement. If necessary, place a dry towel between arm and side and/or between thighs.**

**Do not take measurements while using transmitting devices, such as mobile phones, which may affect readings.**



Required

**Use the equipment under the same conditions and in the same position as much as possible for accurate tracking of changes.**

Readings are affected by the level of hydration and position of the body. Please use at the same time of day each time, under the same conditions and in the same body position.



**Avoid measuring in multiple locations with greatly differing temperatures.**

This may cause inaccurate measurements. Allow the equipment to stand for at least 2 hours before using if it is moved to a new location with a temperature difference of 20°C or more.

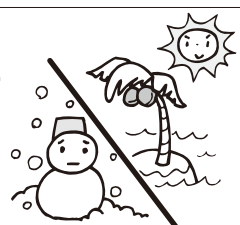

**Make sure the soles of feet are free of excess dirt, as this may block the mild electric current.**

**Always hold both arms straight down when taking measurements to prevent measurement errors such as undermeasurement of body fat.**

**Bare feet should be placed correctly on the electrode platform. Place arms straight down during measurement.**

**Use in a stable location.**

Errors in measurements may occur if the device is used in an unstable location.

# Scheduled Maintenance



Required

**TANITA recommends that each facility conduct periodic checks of each unit.**

1. Check the following at least daily:
  - The unit is on a stable and level surface ie on a firm flooring, not on a thick carpet
  - Date and time settings
2. Visually inspect the following at least weekly:
  - The display for any damage or contamination
  - All cables, cords, and connector ends for damage or contamination
  - All safety-related labeling for legibility
  - All accessories (sensors, electrodes, etc.) for wear or damage
3. Visually inspect the following at least monthly:
  - Mounting screws on stand

**Update settings, replace items, or call for service as necessary according to the results of the visual inspections. Do not use the unit if you see any signs of damage. Equipment that has been damaged must be checked for proper operation by qualified personnel before using again.**

# Part Names & Connection Procedure

en

Before Use

## Symbols and their Meanings

	Conformity with Medical Device Directive 93/42/EEC		Serial interface
	Alternating current		Direct current
	Input, Output		Class II Equipment
	Manufacturer		Type BF applied part - Grips and platform
	Caution Refer to the attached notes.		WEEE - Waste Electrical and Electronic Equipment Directives
	SD card		For indoor use only
	Serial number		See the instructions

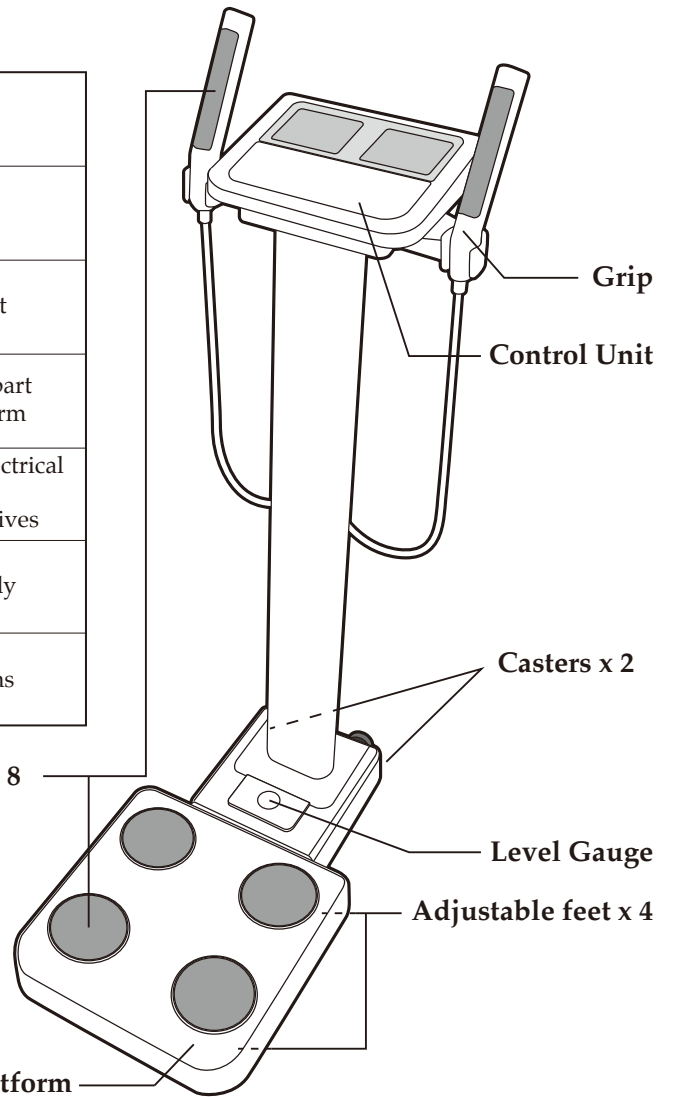

## Checking the level

- \* For accurate measurement, place the machine as level as possible.
- \* Rotate the adjustable feet in 4 positions for adjustment so that the bubbles of the level gauge reach the centre.

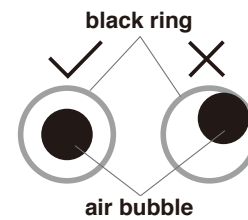

Status when the level gauge is viewed from above

## Control unit Connection of Plugs

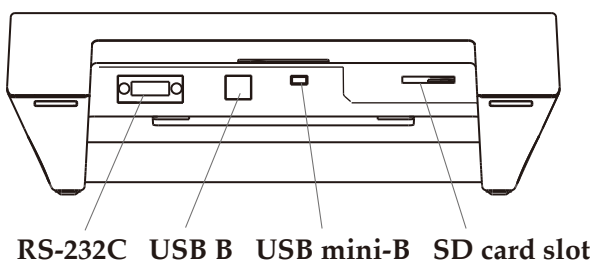

## Platform Connection of Plugs

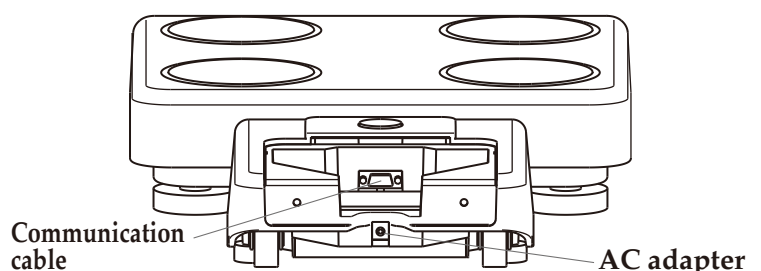



## Display and Keys

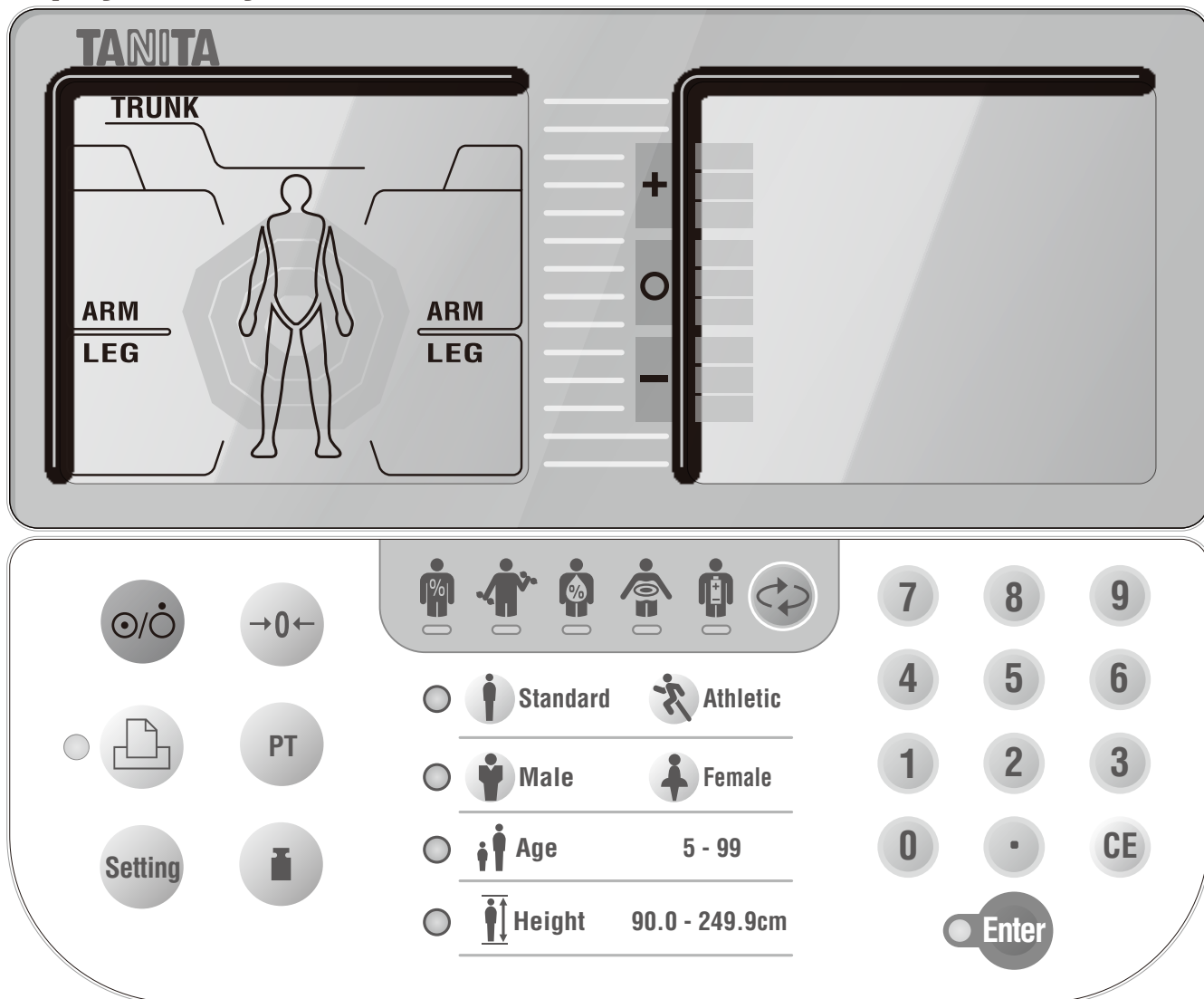

### Meanings of the LED Indicators and Keys

	Turn ON / OFF the power
	Printout result
	Set various functions
	Reset zero point
	Set preset value (Clothes weight)
	Select measurement mode

	Display Body Fat (percentage and mass) *Not measured value but calculated value		
	Display Body Muscle (percentage and mass) *Not measured value but calculated value		
	Display Body Water (percentage and mass) *Not measured value but calculated value		
	Display Visceral Fat Rating		Display Basal Metabolic Rate
<input type="radio"/>	<input type="radio"/>	Indicates whether "Standard mode or Athletic mode" is selected as the body type.	
<input type="radio"/>	<input type="radio"/>	Indicates whether "Male or Female" is selected as the gender	
<input type="radio"/>	Age 5 - 99	Enter the age between "5 to 99 years old"	
<input type="radio"/>	Height 90.0 - 249.9cm	Enter the height between "90.0 to 249.9 cm"	
	Confirms the entered numerical value.		

# Power Supply

en

Before Use

## Turning the Main Power ON/OFF

Turning the main power ON.

Press the  key to turn on the power.

The initial screen is displayed.

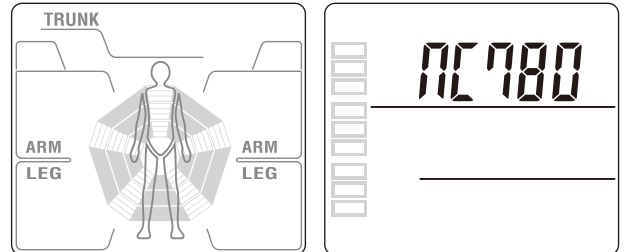

Turning the main power OFF.

Press the  key to turn the power off.

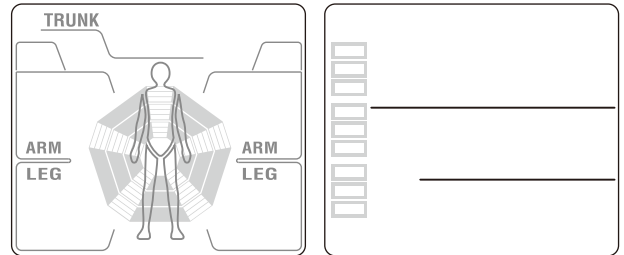

## Emergency Shut Down

Keep the area around the plug socket clear during operation of the equipment in case of an emergency.

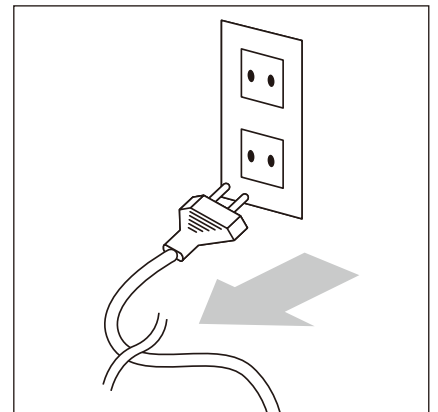

# Settings

**1** Press the  key to change the mode.

The setting screen is displayed.



**Note**

•The  key cannot be used when the scale is measuring weight or impedance.

**2** Select the setting item from the list below.  
Enter numerical values and Press the  key.

**Setting item List**  → Save changes and return  → Return without saving

No.	Setting Item	Default	Page	No.	Setting Item	Default	Page
0	Check the software version	-	-	10	Height input unit 0: 0.1cm increments 1: 1cm increments	0	P.14
1	Date and time	-	P.11	11	Automatic determination time of input information 0-9 second(s) * 0: disables this function	0	-
2	Number to be printed automatically (body composition mode) 0-2 sheet(s)	0	P.21	18	Target body fat ratio input 0: off 1: on	0	P.14
3	Number to be printed automatically (scale mode and weight lock mode) 0-2 sheet(s)	0	P.21	19	Printout language 1: English, 2: French, 3: German, 4: Italian, 5: Spanish	1	-
4	Select printing paper 0: pre printed paper 1: plain paper	1	-	20	Adjust printing position 2: ↓, 4: ←, 6: →, 8: ↑	-	-
5	Beep sound 0: off 1: on	1	-	21	Timeout function of result display 0: disable 1: enable	0	-
6	ID number (manual input) 0: off 1: on	0	P.13	30	Data output format to PC 0: default format 1: BC-418 format	0	P.21
7	ID number (automatic count up) 0: off 1: on	0	P.13	31	Display direction 0: default 1: reversal position	0	-
8	Measurement flow 0: two step flow (measure body weight first) 1: one step flow (enter personal information first)	0	P.13	32	BMI desirable range 0: 18.5 to 24.9 1: 18.5 to 22.9 2: 18.5 to 23.9	0	-
9	Body type selection (athletic mode) 0: off 1: on	0	P.13	60	Reading stored measurement result	-	P.22

**Note**

Enter the year, month, day, hour and minute.  
The date format is "yyyy mm dd hh:mm"

**Example** 6:47 pm, 24th September, 2012  
"2012" "09 24" "18:47"

To enter a number with 1 digit (0 to 9), press "0" first.

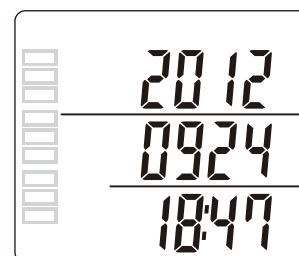

# Settings (continued)

en

Before Use

## Select the Measurement Mode

Select the measurement mode by pressing the  key.

The measurement mode is switched in the following order when the  key is pressed:

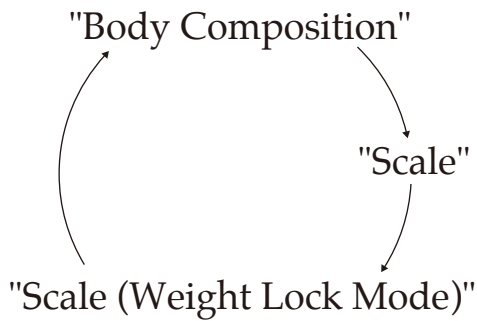

The "" mark is displayed when the scale mode is selected.

### Body Composition Mode

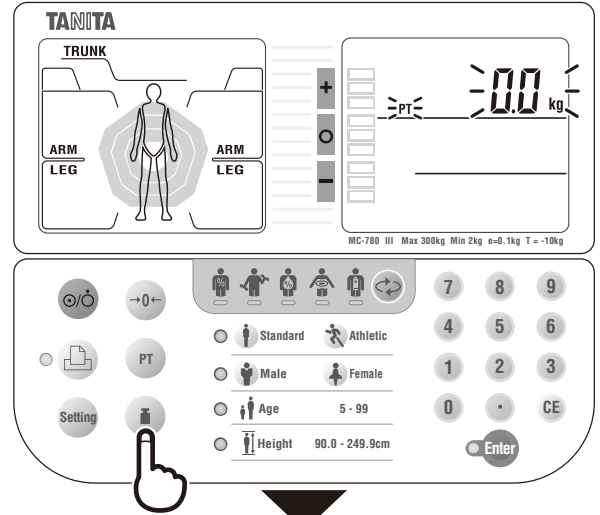

### Scale Mode

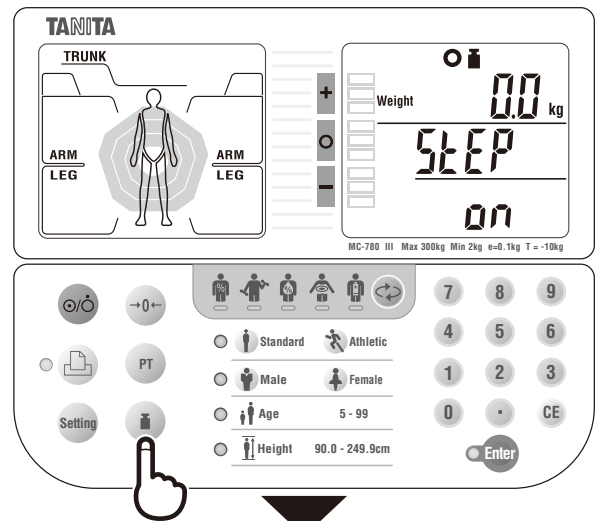

### Scale Mode (Weight Lock Mode)

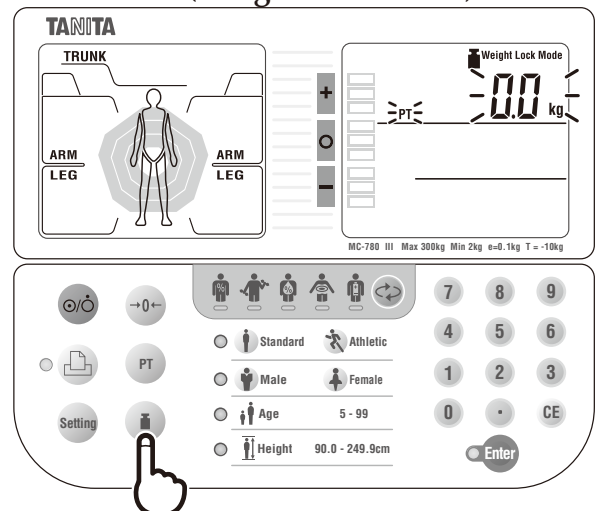

# Taking a Measurement

## Body Composition Mode (Two step flow Measure body weight first)

### 1 Enter the preset tare value (clothes weight) and press **Enter** key

Turn the power on, and check that the "PT" mark flashes.  
Enter the preset tare value (clothes weight)  
The tare value range is 0.0 to 10.0kg.

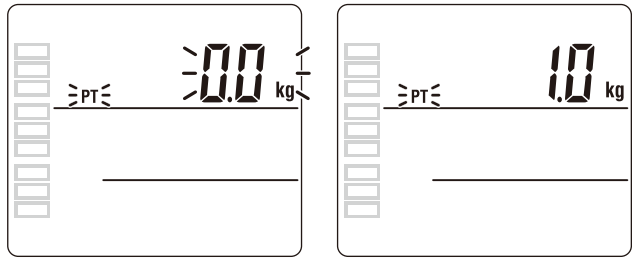

### 2 Measure body weight

Step onto the scale, after "STEP on" is displayed.  
"NET" is displayed when you have entered a tare value (clothes weight).

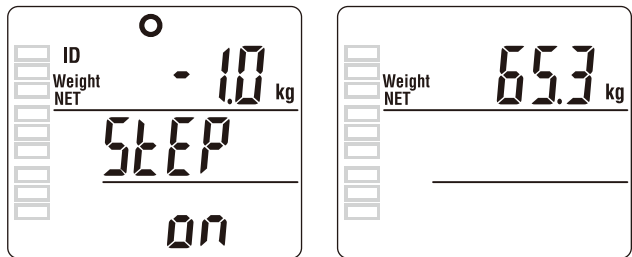

#### Note

When the One step flow is selected, enter personal information first. → P.11 Setting 8  
If the scale does not detect a load, press **Clothes Weight (PT)** to switch to "Input tare value".  
If the scale detects the load, press **Clothes Weight (PT)** to display the entered tare value.

### 3 Enter ID number

If the ID number function is set to OFF, the scale switches directly to "Select body type" without requesting an ID number.

The ID number range : 0 to 9999999999999999

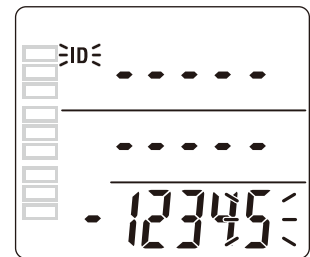

### 4 Select body type **Standard** **Athletic**

If the body type selection (Athletic mode) is set to OFF, the scale switches directly to "Select gender" without requesting a body type.

The "⚔" mark is displayed when the Athletic mode is selected.

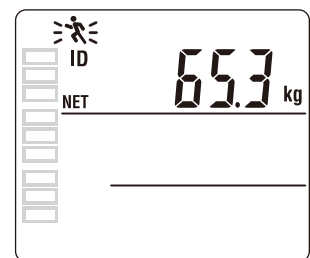

#### Note

Athletic mode setting → P.11 Setting 9  
Athlete condition → P.19

# Taking a Measurement (continued)

en

How to Use

## Body Composition Mode

**5** Select gender  Male  Female

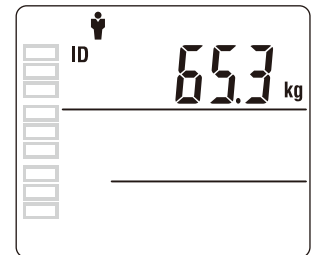

**6** Enter age  Age and press  key

The age range : 5 to 99

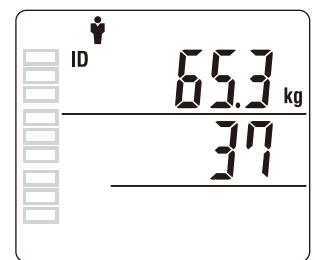
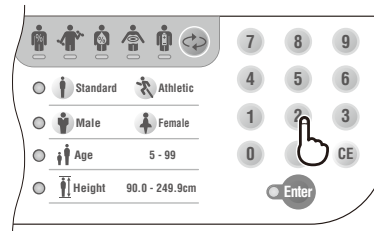

**7** Enter height  Height and press  key

The height range : 90.0 to 249.9 cm

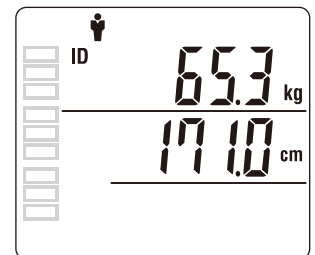
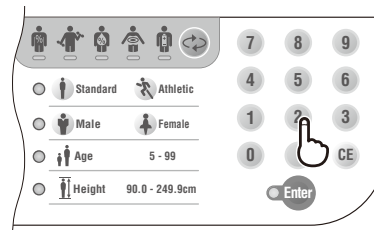

**8** Set target body fat ratio

If the target body fat ratio function is set to OFF, the scale switches directly to "Measuring body composition" without entering the target value.

The body fat ratio range: 4 to 55 %

**Note**

Target Body Fat Ratio setting → P.11 Setting 18

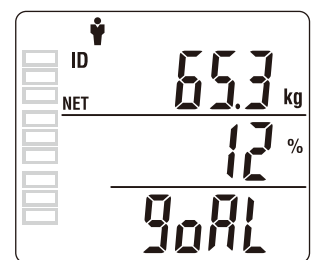

**9** Measuring body composition

Hold the grip, when "grip on" is displayed.

The scale starts measuring impedance after you have entered all of the personal information.

The segmental impedance values are measured in order.

The scale displays the measurement results after measuring the whole body impedance and segmental impedance.

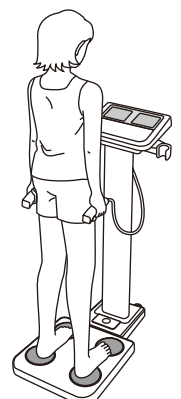
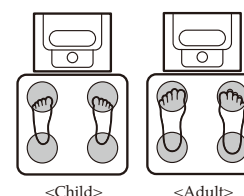
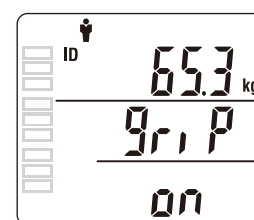

# Measurement Results (Body Composition Mode)

## Output Measurement Results (Body Composition Mode)

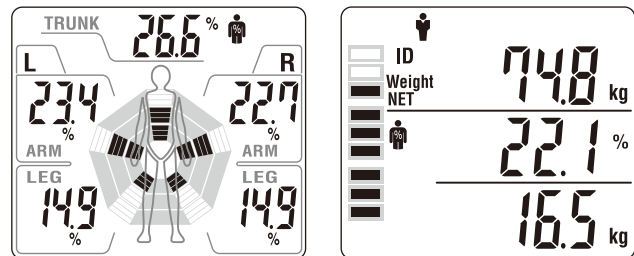

The measurement results are displayed on the LCD after measurement is completed.  
The results are output to the PC immediately after measurement is completed.

Press the key to select the measurement display.

The measurement display is switched in the following order by pressing the key.

"Body Fat" → "Muscle" → "Body Water" → "Visceral fat rating" → "Basal metabolic rate" → "BMI"

### Body Fat

Fat icon

Segmental fat %

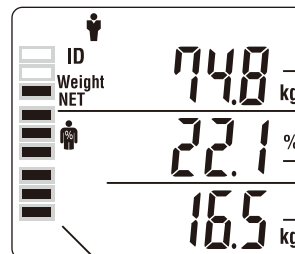
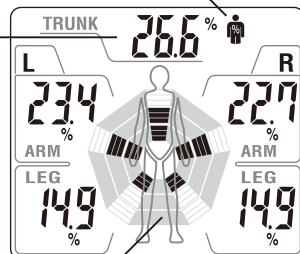

Body weight (kg)

Body fat %

Body fat mass (kg)

Evaluation of your results compared to average values.

Fat rating

### Muscle

Muscle icon

Segmental Muscle Mass

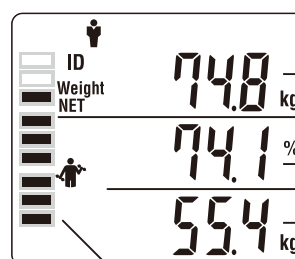
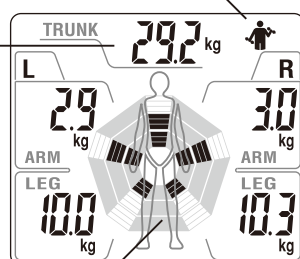

Body weight (kg)

Body muscle %

Body muscle mass (kg)

Evaluation of your results compared to average values.

Muscle mass rating

# Taking a Measurement (continued)

en

How to Use

## Measurement Results (Body Composition Mode)

### Body Water

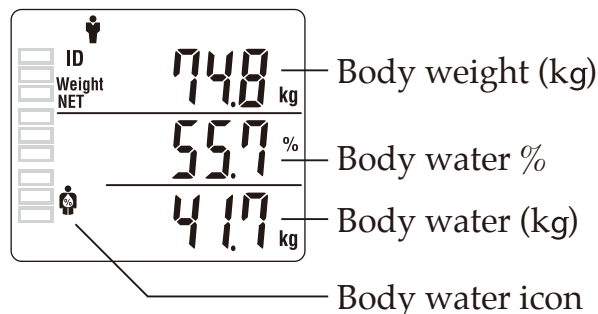

### Visceral Fat Rating

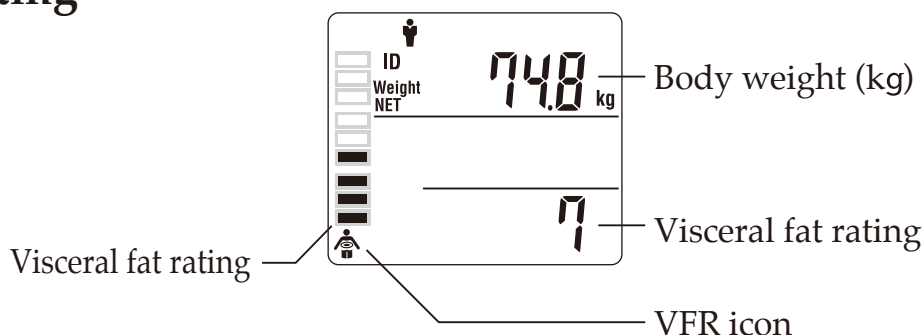

### Basal Metabolic Rate (BMR)

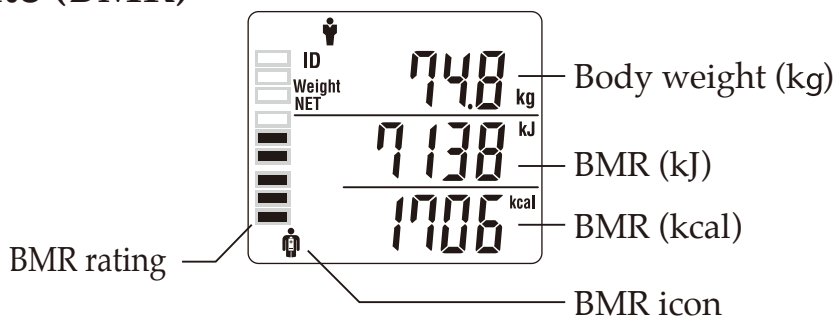

### Body Mass Index (BMI)

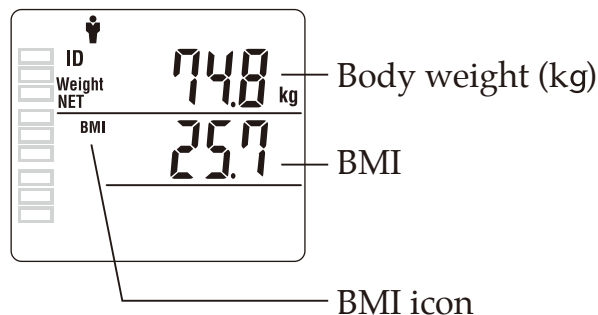

#### Note

“○” flashes if measuring posture is incorrect.  
The results can only be used as reference data. → P.6





# Scale Mode

The "I" icon is displayed when the scale mode is selected.

## 1 Enter the ID number

If the ID number function is set to OFF, the scale starts measuring weight immediately.

Enter the ID number.

The ID number range is from 0 to 9999999999999999.

Press **PT** to enter tare value (clothes weight).

The tare value range is 0.0 to 10.0kg.

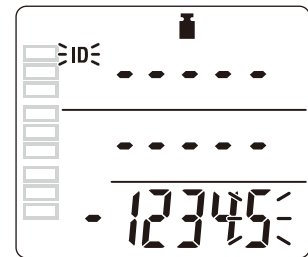

## 2 Measure body weight

"NET" is displayed when you have entered a tare value (clothes weight).

Step onto the scale, after "StEP on" flashes.

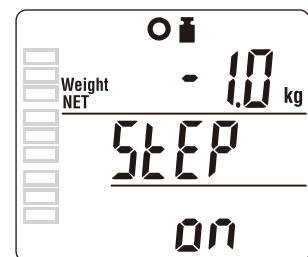
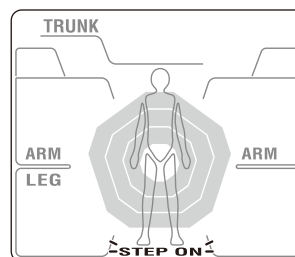

The "Stabilised" icon (●) appears when the load is stable. The "Stabilised" icon (○) disappears when the load is unstable.

When the load is stable, the measurement results are output via the USB port and stored on an SD card.

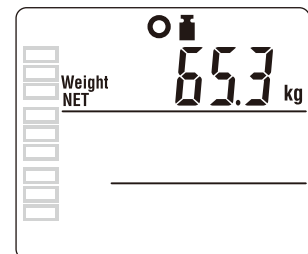

# Taking a Measurement (continued)

en

How to Use

## Weight Lock Mode

The "🔒" icon and "Weight Lock Mode" are displayed when the weight lock mode is selected.

### Enter the preset tare value (clothes weight)

Enter the preset tare value (clothes weight)  
The tare value range is 0.0 to 10.0kg.

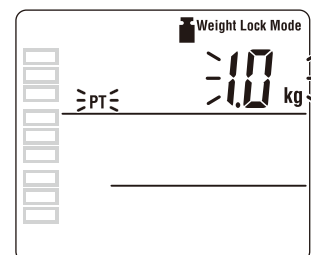

### Enter the ID number

If the ID number function is set to OFF, the scale starts measuring weight immediately.

Enter the ID number.  
The ID number range is from 0 to 9999999999999999.

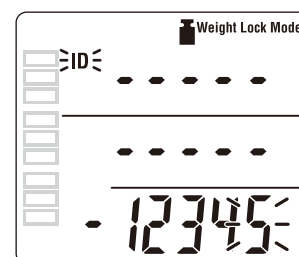

### Measure body weight

"NET" is displayed when you have entered a tare value (clothes weight).

Step onto the scale, after  
"STEP on" flashes .

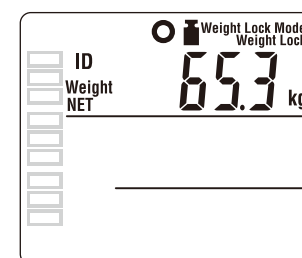
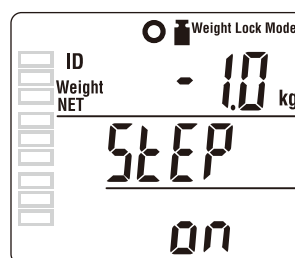

The "Stabilised" icon (●) appears when the load is stable.  
The "Stabilised" icon (○) disappears when the load is unstable.

When the load is stable, the measurement results are output via the USB port and stored on an SD card.

# General Instructions for Body Composition Measurement

## Athletic Mode

- **Recommended for those who are 18 years or older and meet the following conditions.**
  - People who carry out 12 hours or more of cardiovascular exercise a week.
  - People who belong to a sport team or a sport organization with the aim of participation in competition, etc.
  - People who are professional athletes.

## Target Body Fat

- **A target body fat % should be set by a professional only. Tanita is not responsible for setting the appropriate target body fat % for specific individuals.**

## Attention

- **Posture when measuring**
  - Stand with both feet parallel on the electrodes.
  - Stand without bending knees.
- **The age input range is 5 to 99 years old.**  
**Input age 99 for those who are 100 years or older.**
- **Contact condition**
  - If your inner thighs are touching or your arms make skin-to-skin contact, the results can only be used as reference data. → P.6

## Note

- Inaccurate results may be reported after excessive food/fluid intake, or after periods of intense exercise.
- If clothes weight is input, clothes weight is subtracted from the weight measurements.



# Judgment Results

## Healthy Range Indicator

Your Body Composition Analyzer automatically compares your body fat percentage reading to the Healthy Body Fat Range chart. After your body fat percentage has been calculated, the LCD on the side of the display will light up, identifying where you fall within the Body Fat Ranges for your age and gender.

## Note

- Please refer to the Technical Notes for the Healthy Body Fat Range chart.

- 
**Overfat and Obese**
  - Overfat; above the healthy range. Increased risk for health problems.
  - Obese; high above the healthy body fat range. Greatly increased risk of obesity-related health problems.
- 
 Healthy; within the healthy body fat percentage range for your age/gender.
- 
 Underfat; below the healthy body fat range. Increased risk for health problems.

## Note

- Athletes may have a lower body fat range depending on their particular sport or activity.

# Taking a Measurement (continued)

en

## Body Water and Extracellular Water

---

How to Use

Body water can be broadly classified into extracellular water and intracellular water. The percentage of this water accounted for by extracellular water is known as the extracellular water ratio.

In medical textbooks, this is defined as:

Extracellular Water (ECW): Intracellular Water (ICW) = 1:2 (i.e. an extracellular water ratio of 33%.)

Swelling and dehydration are often diagnosed when this ratio is compromised.

But is this really correct? Can swelling or dehydration occur simply by deviating from this ratio? Drinking water does indeed change the body's fluid distribution, but caution is required when determining this figure.

**Just as variation exists in different people's body composition, variation also exists in different people's volume of body water and extracellular water ratio.**

The appropriate data can be obtained by measuring a person's body composition. Just one measurement however, is not enough to draw a conclusion. This figure needs to be looked at over a period of time.

Your health can be better managed by examining this figure along with other indicators such as weight and body fat.

# Output and Storage of Measurement Results

## Data Output

### Outputting measurement results via the USB or RS

The results are output to the PC immediately after measurement is completed.

Data is output in CSV format.

- USB connector (Type-B 4 - pin female) are located on the back of the control box.
- Please provide your own cable as necessary as none are included.

USB cable : Type-A 4 - pin (male) - Type-B 4 - pin (male)

- You must install the necessary driver onto your PC, available download from <http://www.tanita.eu>

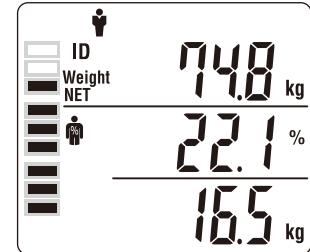
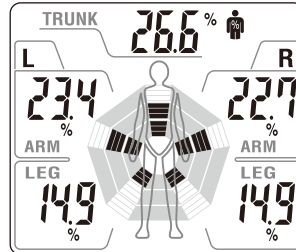

## Data Storage

### Data storage of measurement results

The results are saved to the SD card immediately after measurement is completed.

The  icon is displayed when a valid SD card is installed.

A new file is created on the SD card for each day.

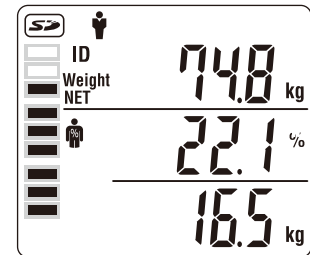
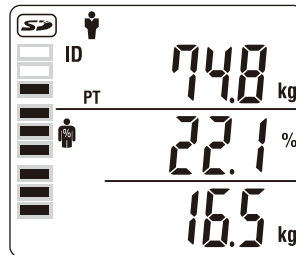

The file is created using the measurement date and time as the file name, as shown below. "YYYYMMDD" (year, month and date)

If "error 12" is shown in the display, this indicates that there is not enough free space left on the SD card.

You can store approximately 10,000 measurement results (weight only mode) on a 2GB SD card.

- Do not remove the SD card when it is storing or reading data.
- Do not turn off the main power when the SD card is storing or reading data.

## Printing Data

### Printing Measurement Results

The results are printed from the printer immediately after measurement is completed.

The number of sheets that are printed is set in .

Press the  key to print additional copies.

You can print out the result if  is lighted.

# Output and Storage of Measurement Results (continued)

en

How to Use

## Reading Stored Measurement Result Data

### Reading stored measurement result data (→P.11 Setting 60)

Select the file that you want to load using the or key and or key and press **Enter**.

Displaying stored data  
Date and time when the displayed data was measured  
Year, Month and date  
Hour, Minute and Second

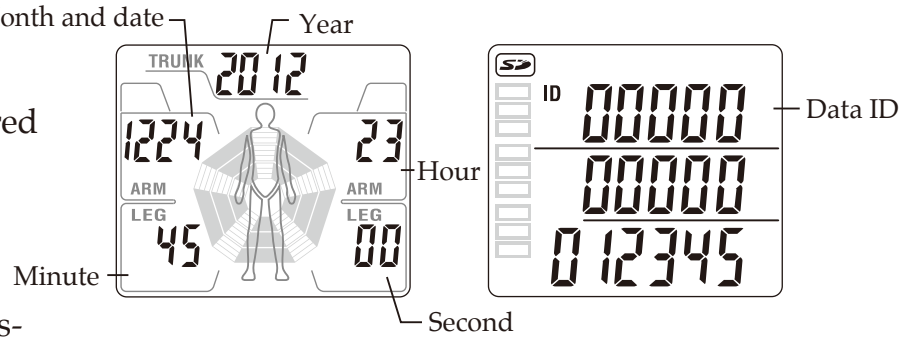

Switch the display by pressing the key.

- Print
- Enter** → Next data
- CE** → Exit

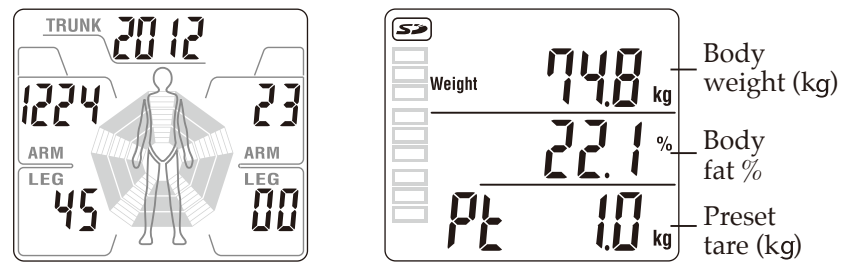

# Troubleshooting

Please check the following before requesting repair.

	Problem	Solution
Measurement	Error with impedance measurement	<ul style="list-style-type: none"> <li>• Hold the handgrips and electrodes firmly with fingers and palms.</li> <li>• Stand barefoot on the platform for measurement.</li> <li>• If the soles of the feet are dry, use a dropper to apply about 0.5 mL of water before measurement.</li> <li>• Check the input details.</li> </ul>
	Error with zeroing	<ul style="list-style-type: none"> <li>• Turn off the power and remove anything on the platform, then turn on the power and try measuring again.</li> </ul>
	The weight value does not stabilize.	<ul style="list-style-type: none"> <li>• Is the equipment placed on a vibrating surface?</li> <li>• Is the measuring platform tilted?</li> <li>• Is something blocking the gap in the measuring platform?</li> <li>• Remove any inserted objects.</li> </ul>
Display	Nothing is displayed, even when the power is turned on.	<ul style="list-style-type: none"> <li>• Confirm that the power is connected correctly.</li> </ul>
	"-----" is displayed.	<ul style="list-style-type: none"> <li>• The measured weight exceeds weighing capacity.</li> </ul>
	"○" flashes.	<ul style="list-style-type: none"> <li>• "○" flashes if measuring posture is incorrect. The results can only be used as reference data. → P.6</li> </ul>

If Necessary

# Specifications

en

If Necessary

<b>Model Number</b>		MC-780MA-N
<b>Accuracy Grade</b>		MDD: CLASS IIa NAWI: CLASS III
<b>Power Source</b>		100 to 240V AC
<b>Electric Current Range</b>		18VA
<b>Impedance Measurement</b>	<b>Measurement System</b>	Multi-Frequency 8 Electrode
	<b>Measurement Frequency</b>	5kHz/50kHz/250kHz
	<b>Measurement Current</b>	90 $\mu$ A or less
	<b>Electrode Materials</b>	Feet: Stainless steel/Handgrips: plated
	<b>Measurement Part</b>	Whole body/Right arm/Left arm/Right leg/Left leg
	<b>Measurement Range</b>	75.0 to 1,500.0 $\Omega$ (0.1 $\Omega$ increments)
	<b>Accuracy at First Calibration</b>	$\pm$ 2%
<b>Weight Measurement</b>	<b>Measurement System</b>	Strain Gauge Load Cell
	<b>Maximum Capacity</b>	270kg (including preset tare value)
	<b>Minimum Graduation</b>	0.1kg
	<b>Accuracy at First Calibration</b>	$\pm$ 0.2kg
<b>Display</b>		Dual LCD screen
<b>Interface</b>		USB Type-B Port (device)
		RS-232C
		USB mini-B (for PictBridge printer)
		SD card
<b>Product Weight</b>		Column Mounted type: 15.5kg/Separate type: 11.1kg
<b>Product Size</b>	<b>Platform</b>	Platform size: 360 x 360mm    Height: 94mm
	<b>Height(Column Mounted Version)</b>	1165mm



Input items	Clothes Weight		0 to 10.0kg (0.1kg increments)	
	Serial No.		Up to 16 digits	
	Gender		Female/Male	
	Body Type		Standard/Athletic* <sup>1</sup>	
	Age		5 to 99 years old	
	Height		90.0 to 249.9cm (0.1cm increments)	
	Target Body fat %		4 to 55% (1% increments )	
Output items* <sup>3</sup>	ID		16 digits	
	Gender		Female/Male	
	Body Type		Standard/Athletic* <sup>1</sup>	
	Age		5 to 99 years old	
	Height		90.0 to 249.9cm (0.1cm increments)	
	Clothes Weight		0 to 10.0kg (0.1kg increments)	
	Whole Body Analysis	Weight	0 to 270.0kg (0.1kg increments)	5 to 99 years old
		Fat %	3.0 to 75.0% (0.1% increments)	
		Fat Mass	0.1kg increments	
		FFM	0.1kg increments	
		Fat Rating	-4 to +4 (1 increments)	
		Muscle Mass	0.1kg increments	18 to 99 years old
		Muscle Mass Rating	-4 to +4 (1 increments)	
		BMI	0.1 increments	5 to 99 years old
		Bone Mass	0.1kg increments	18 to 99 years old
		Metabolic Age	1 increments	
		Basal Metabolic Rate	1kcal/1kJ increments	
		Visceral Fat Rating	1 to 59 (1 increments)	18 to 99 years old
		TBW	0.1kg increments	5 to 99 years old
		TBW %	0.1% increments	18 to 99 years old
		ECW	0.1kg increments	
	ICW	0.1kg increments		
	ECW / TBW	0.1% increments		
	Segmental Analysis	Muscle Mass	0.1kg increments	5 to 99 years old
		Muscle Mass Rating	-4 to +4 (1 increments)	18 to 99 years old
		Fat %	0.1% increments	5 to 99 years old
		Fat Mass	0.1kg increments	
		FFM	0.1kg increments	
	Fat Rating	-4 to +4 (1 increments)	18 to 99 years old	
	Body Balance Evaluation	Physique Rating		
Muscle Mass Balance				
Leg Muscle Score				
Others	MM/H <sup>2</sup>	Whole body Muscle Mass (kg)/Height(m) <sup>2</sup>	5 to 99 years old	
	MM/BW	Whole body Muscle Mass (kg)/Body Weight(kg) Total muscle mass value of Right arm, Left arm,		
	SMI*	Right leg and Left leg (kg)/Height(m) <sup>2</sup> Total muscle mass value of Right arm, Left arm,		
	ASM**/BW	Right leg and Left leg (kg)/Body Weight(kg)		
	Bioelectrical data	Reactance/Resistance/Phase Angle		
Contact Condition* <sup>2</sup>				

\*1 Athletic mode can be selected only for ages 18 to 99.

\*SMI: Skeletal Muscle Mass Index

\*2 The results can only be used as reference data. → P.16

\*\*ASM: Appendicular Skeletal Muscle Mass

### Note

Compatible with SD and SDHC memory cards.  
Not compatible with SDXC memory cards.



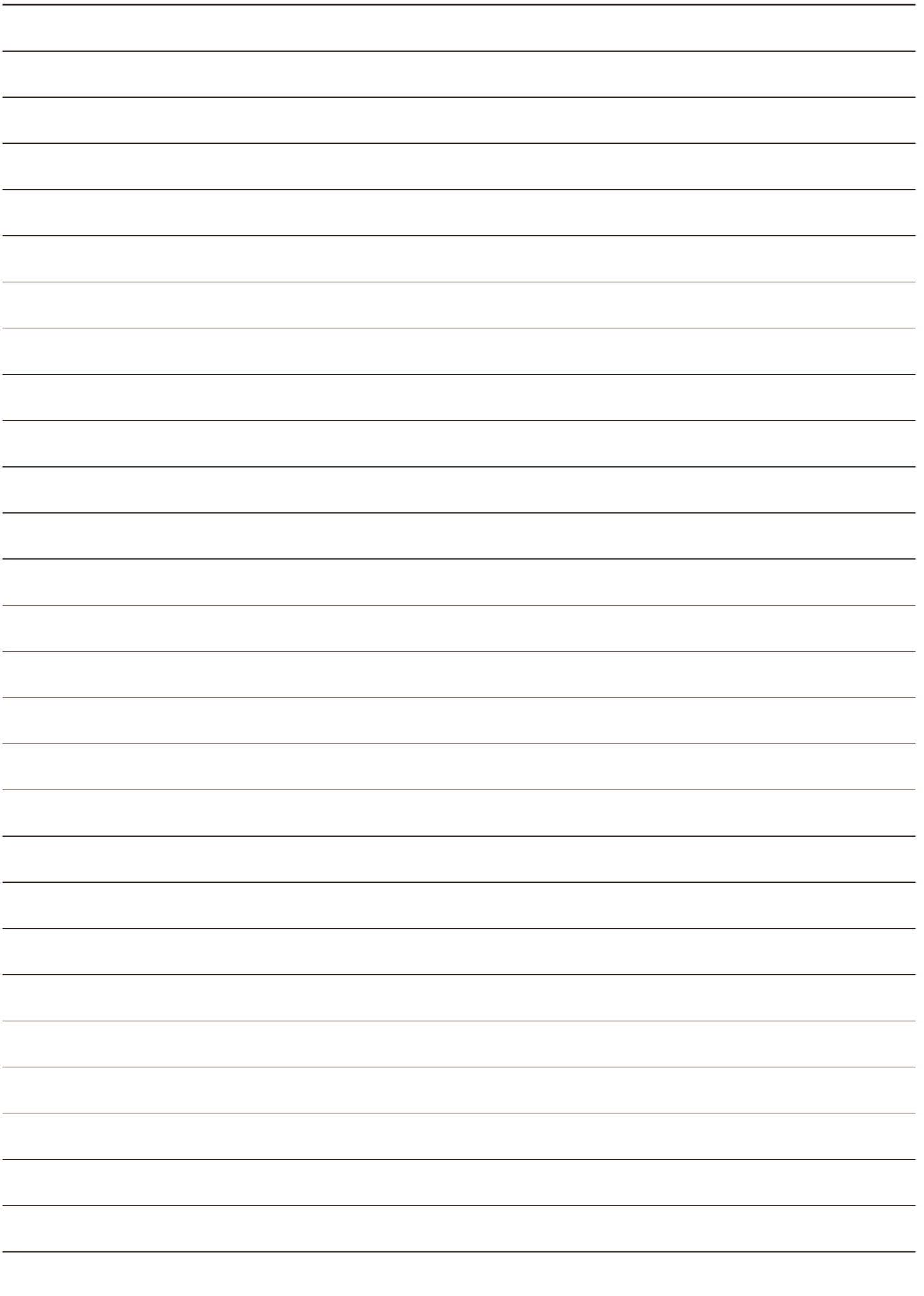



0122 This product meets the following requirements ;  
0123 1. Non-Automatic Weighing Instruments (2014/31/EU)  
2. Medical Device Directive (93/42/EEC)  
3. RoHS Directive (2011/65/EU)

- The product design and specifications may be changed at any time without prior notice.
- SD, SDHC and SDXC Logos are trademarks or registered trademarks of SD-3C LLC in the United States, other countries or both.
- PictBridge and the PictBridge logo are trademarks of the Camera & Imaging Products Association (CIPA).

**<Manufacturer>**  
**TANITA Corporation**

1-14-2 Maeno-cho, Itabashi-ku,  
Tokyo 174-8630 Japan  
TEL: +81-(0)3-3968-7048  
www.tanita.co.jp

**TANITA Health Equipment H.K. Ltd.**

Unit 301-303, Wing On Plaza, 3/F.,  
62 Mody Road, Tsimshatsui East, Kowloon,  
Hong Kong  
TEL: +852-2834-3917  
FAX: +852-2838-8667  
www.tanita.asia

**<EU Representative>**  
**TANITA Europe B.V.**

Hoogoorddreef 56-E, 1101 BE  
Amsterdam, the Netherlands  
TEL: +31-(0)20-560-2970  
FAX: +31-(0)20-560-2988  
www.tanita.eu

**TANITA (Shanghai) Trading Co., Ltd.**

Room 8005, 877 Huai Hai Zhong Lu,  
Shanghai, The People's Republic of China  
TEL: +86-21-6474-6803  
FAX: +86-21-6474-7901  
www.tanita.com.cn

**TANITA Corporation of America, Inc.**

2625 South Clearbrook Drive,  
Arlington Heights, Illinois 60005  
U.S.A.  
TEL: +1-847-640-9241  
FAX: +1-847-640-9261  
www.tanita.com

**TANITA India Private Limited**

A-502, Mittal Commercial,  
Off. M.V. Road (Andheri Kurla Road),  
Marol, Andheri-East, Mumbai 400059,  
Maharashtra, India  
TEL: +91-771-801-1511 / +91-771-801-1382  
FAX: +852-2838-8667  
www.tanita.co.in

## Disposal



This equipment is an electronic device.  
Please therefore dispose of it as an electronic  
device instead of as general household  
waste. Please follow regional regulations for  
disposal.